

FLEXEM——Resistive HMI FE6000 Series

Model: FE6100M

Overview

Flexem Industrial HMI 6000 Series, a new generation of IIoT human-machine interface. It is high-quality and cost-effective touch screen, industrial ABS plastic shell, low cost, high reliability. The mainboard is treated with a special coating (three anti-paint) to adapt to harsh environments. The new model opens with a more practical down-line approach, and the redesigned front face has a better looking look, and higher resolution model is available. By selecting the Flink IIoT module, you can upgrade IIoT human-machine interface immediately and uses complete and convenient industrial IIoT cloud platform service.



Appearance



Specifications

Hardware parameter	Display	10.1" 16:9 TFT LCD
	LCD viewing angle (T/B/L/R)	85°/85°/85°/85°
	Resolution (WxH)	1024×600
	Colors	24-bit
	Brightness	400 cd/m ²
	Backlight	LED
	LCD Life	50000 hours
	Touch Panel	4 wires resistive touch screen(Surface hardness 4H)
	CPU	600MHz ARM Cortex-A8
	Memory	128M Flash + 128M DDR3
	RTC	Built in
	SD card Port	Micro SD (TF)
	Ethernet	1 way 10M/100M adaptive
	USB Port	USB Slave 2.0 port*1,USB Host 2.0 port*1
	Download Project	USB Slave/U disk / Ethernet
COM Port	COM1: RS232/RS485/RS422; COM2: RS485/RS422 COM3: RS232	
Electrical Specifications	Power Consumption	< 10W
	Input Power	DC24V, working range DC 9V~28V
	Power Protection	Protected from thunderstrike and surging
	Power Down Allowed	< 5mS
	CE & RoHS	Complied with EN61000-6-2:2005, EN61000-6-4:2007, RoHS, Surge Immunity:±1KV, EFT:±2KV,ESD:4KV, Air:8KV
Environmental Specifications	Operating Temperature	-10~60℃
	Storage Temperature	-20~70℃
	Anti-UV	Not suitable to work in strong ultraviolet light (such as direct sunlight)
	Operating Humidity	10~90%RH (non condensate)
	Vibration Endurance	10~25Hz (X,Y,Z direction 2G/30 minutes)
	Cooling	Natural air cooling
Mechanical index	Installation method	Flush mount / VESA mount
	Degree of Protection	Front IP65(with NEMA panel),Back IP20
	Enclosure	Aluminum alloy
	Panel Cutout	260mm×202mm
	Dimension	274mm×214mm×39mm,26mm thickness without extension
	Weight	About 1450g

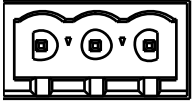
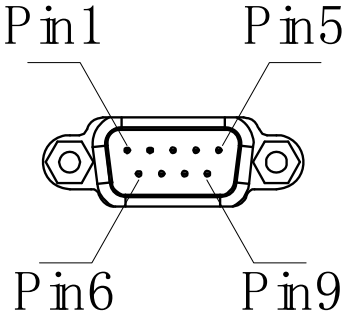
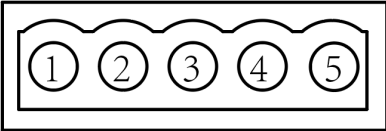
Wiring definition

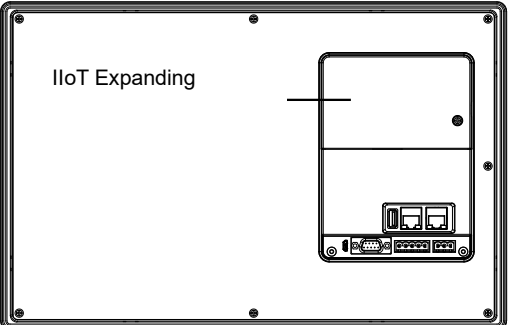
Power terminal (Pin1~Pin3 from left to right)		
	Pin1	DC24V
	Pin2	GND
	Pin3	FG
DB9 Serial terminal(COM1/COM3)		
	Pin1	Rx-(B)
	Pin2	RxD (COM1 RS232)
	Pin3	TxD (COM1 RS232)
	Pin4	Tx-
	Pin5	GND
	Pin6	Rx+(A)
	Pin7	RxD (COM3 RS232)
	Pin8	TxD (COM3 RS232)
	Pin9	Tx+
COM2 Port		
	Pin1	Rx+(A)
	Pin2	Rx-(B)
	Pin3	GND
	Pin4	Tx+
	Pin5	Tx-
USB Host		
	USB Type A	Used to connect U disk, scan code gun and other peripherals
USB Slave		
	MicroUSB	Used to download programs and debug
FLink Expanding Module		
	Expansion module card slot	Support module: FLink FLink-2G-A FLink-4G-A FLink-4G-C FLink-WiFi-A

Size FE61000M

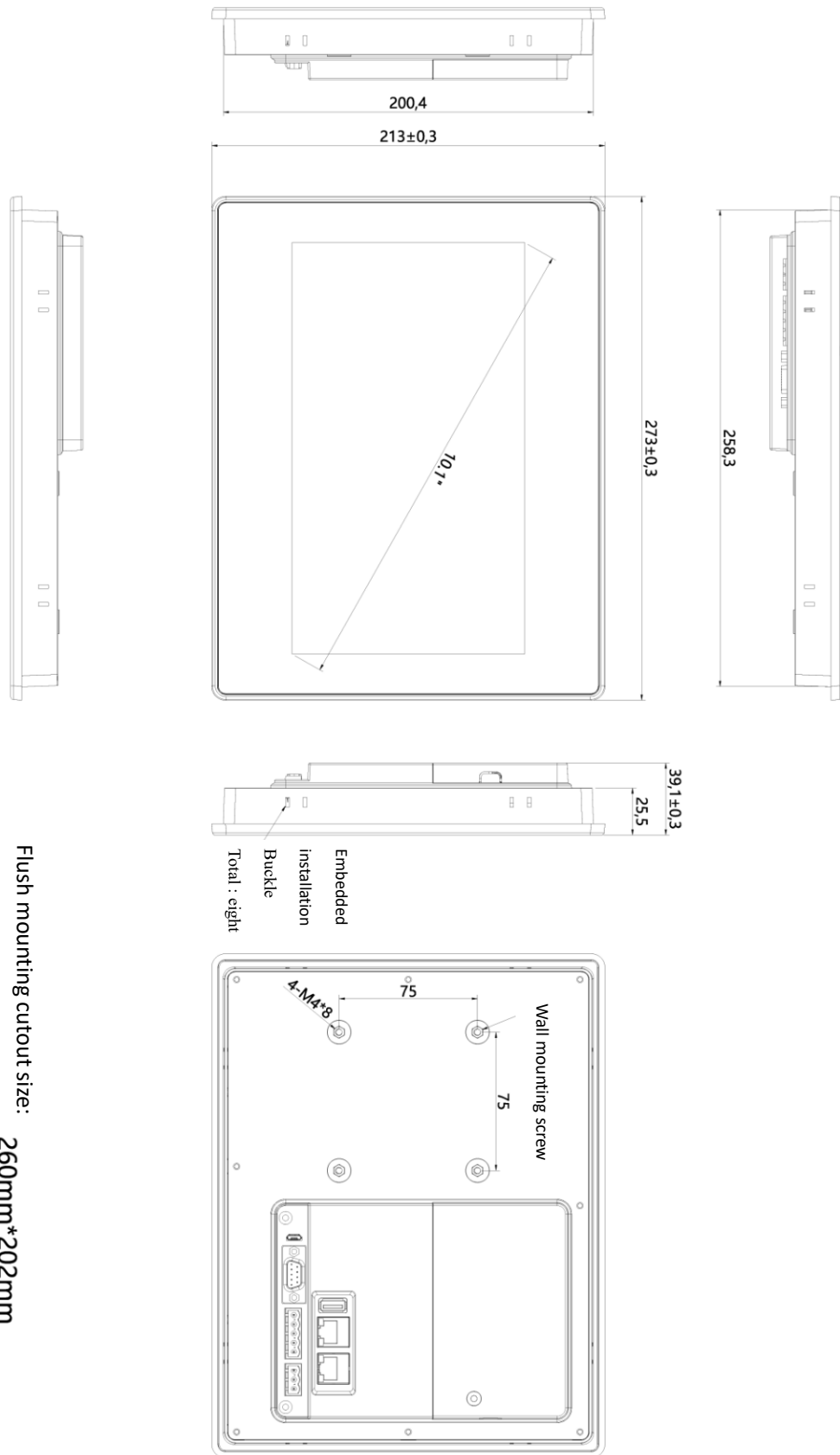

Flush mounting cutout size: 260mm*202mm

FLink Installation diagram

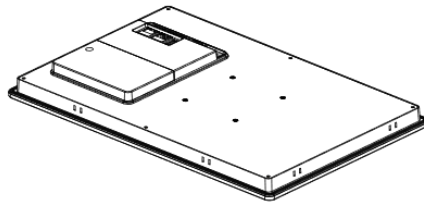
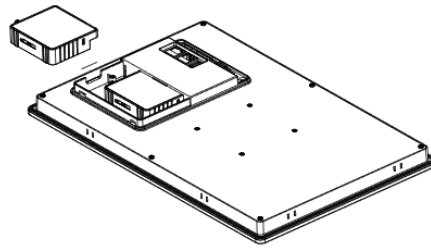
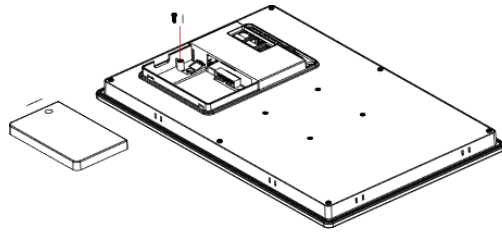

TF Card Installation diagram

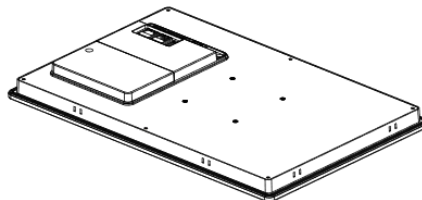
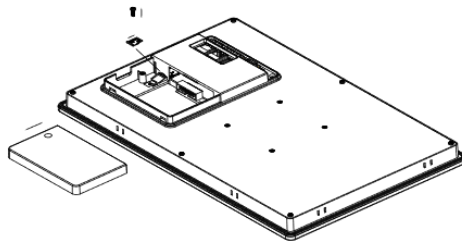

VESA Installation diagram

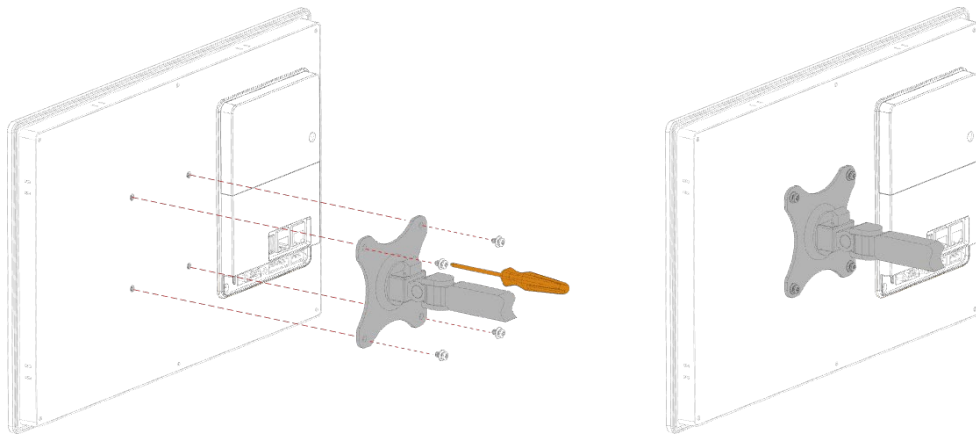

Accessories include: screw PM4 * 8 (excluding hanger).

Contact us

Shanghai (R&D Center)

Address: Floor 11, INNO center,
No 298 Guoxia road, Yangpu district,
Shanghai, 200043.
Telephone: +86-21-68683993
Fax: +86-21-65107569

Suzhou

Address: Room 915, Ricky Building,
No.668, Yuting Avenue, Suzhou
Industrial Park
Telephone: +86-512-69833996

Shenzhen (Factory)

Address: 5th Floor, NO.2 Building,
Lanyun Science Park, Tangtou
Road, Shiyan Town, Baoan
District, Shenzhen, China
Telephone: +86-755-27610682
Fax: +86-755-27629895

Wuxi

Address: Room 1603, Taihu
Mingzhu Development
Building, No. 1890 Taihu
West Road, Binhu
District, Wuxi City
Telephone: +86-18505101982

Beijing

Address: Room 2008, Building 1, No. 93
Jianguo Road, Chaoyang
District, Beijing (Wanda Plaza)
Telephone: +86-10-58204608
Fax: +86-10-58204608

Hangzhou

Address: Room 1005, Building 6,
Dongsha Mingcheng, No.
159, Tiancheng East
Road, Xiasha
Development Zone,
Hangzhou